

POLE SHAFT SPECIFICATIONS				
1.	SHAFTS ARE ONE SECTION DESIGN FABRICATED FROM 6063 T6 ALUMINUM EXTRUSION-SPUN TAPERED.			
2.	BASE CASTING IS 356 T6 ALUMINUM. THE SHAFT TELESCOPES INTO THE BASE CASTING AND IS CIRCUMFERENTIALLY WELDED TOP AND BOTTOM.			
3.	ANCHOR BOLTS ARE "L" FORMED RODS HAVING A MINIMUM YIELD STRENGTH OF 55,000 P.S.I. FABRICATED FROM ASTM F1554 GR. 55 THEN FULLY GALVANIZED PER ASTM A153 SPECIFICATIONS AND FURNISHED COMPLETE WITH 2 HEX NUTS AND 2 FLAT WASHERS.			
4.	POLES SHALL HAVE A POLYESTER POWDER COAT FINISH IN A STANDARD COLOR.			
POLE DIMENSIONS				
POLE HGT. (FT.)	TOP DIA. (IN.)	BOTTOM DIA. (IN.)	GAGE	MTG. HGT. (FT.)
14'	3.00	4.00	.125	14'
BASE PLATE DIMENSIONS				
BOLT CIRCLE (IN.)	BASE PLATE DIM. (IN.)	BOLT HOLE (IN.)	PLATE THK. (IN.)	
7.50-9.00	10.75 SQ	.81	.75	
ANCHOR BOLT DIMENSIONS				
ANCHOR BOLT DIA. (IN.)	ANCHOR BOLT LENGTH (IN.)			
.75	20.00			
ALLOWABLE WIND LOADING (SQ. FT.)				
WIND* EPA	80 MPH	90 MPH	100 MPH	120 MPH
	5.3	3.8	2.7	1.6

*WITH 1.3 GUST FACTOR

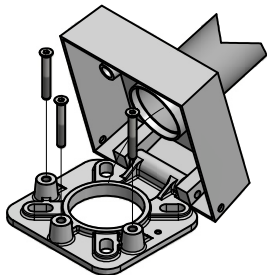

BASE ROTATION DETAIL VIEW

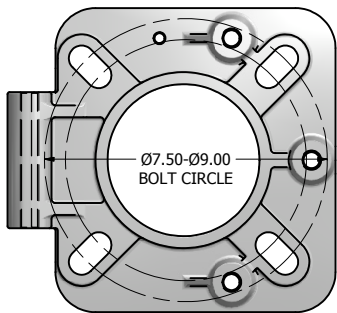

Ø7.50-Ø9.00
BOLT CIRCLE

10.75 SQ.

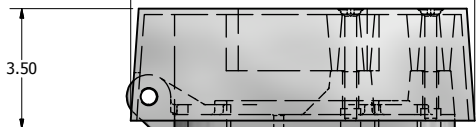

3.50

10.75 X 10.75 X 3.50 THK. BASE CASTING

REMOVABLE CAP

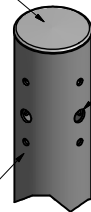

POLE SHAFT

DRILLED PER FIXTURE REQUIREMENTS:
D1- DRILLED FOR 1 FIXTURE
D2- DRILLED FOR 2 FIXTURES AT 90° OR 180°
D3- DRILLED FOR 3 FIXTURES AT 90° OR 120°
D4- DRILLED FOR 4 FIXTURES

DRILLED MOUNT OPTIONS

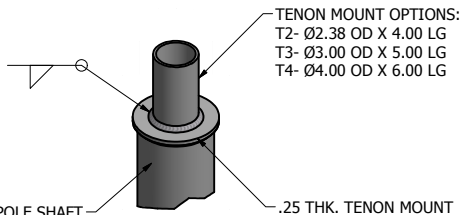

POLE SHAFT

TENON MOUNT OPTIONS:
T2- Ø2.38 OD X 4.00 LG
T3- Ø3.00 OD X 5.00 LG
T4- Ø4.00 OD X 6.00 LG

.25 THK. TENON MOUNT

TENON MOUNT OPTIONS

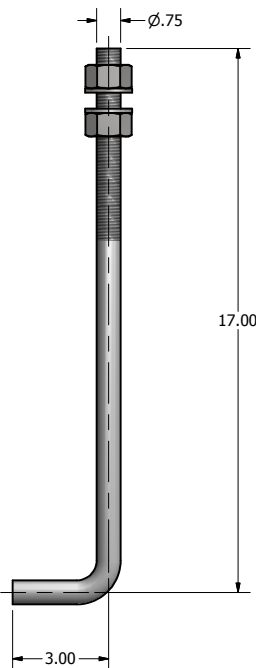

Ø.75 X 20.00 ANCHOR BOLT

POLE HEIGHT
(FT.)

2.00 X 4.00
HAND HOLE
W/ COVER
AT 90° TO HINGE

14.00

POLE DETAIL

lyte poles
a DWM company

P.O. Box 340
Eastpointe, MI 48021
P: (586) 771-4610 | F: (586) 771-5527
www.lytepoles.com

DRAWN: M. HARVALA	2/13/2015
CHECKED:	
REVISION:	DATE:
APPROVED:	
QUOTE:	
S.O.#	
REF:	SCALE: NONE

SOME GEOGRAPHICAL AREAS HAVE SPECIAL WIND CONDITIONS THAT CAN CREATE WIND INDUCED VIBRATIONS CAUSING A FATIGUE PROBLEM. NO METHOD HAS YET BEEN FOUND FOR PREDICTING DESTRUCTIVE LIGHTING POLE VIBRATION. THESE CONDITIONS ARE UNIQUE AND CANNOT BE GUARANTEED AGAINST, AND ARE THE RESPONSIBILITY OF A LOCAL SITE ENGINEER.	
TITLE:	
CATALOG:	
DWG NO: 505-4012-14	SIZE C
SHEET 1 OF 1	

